

03 / INSTRUMENTY LARYNGOLOGICZNE / ENT



prosty • straight • прямой
80.0200



zakrzywiony w lewo • curved left • влево
80.0201

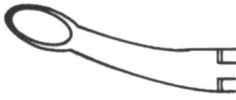

zakrzywiony w prawo • curved right • вправо
80.0202



zakrzywiony do góry • curved upwards • вверх
80.0203

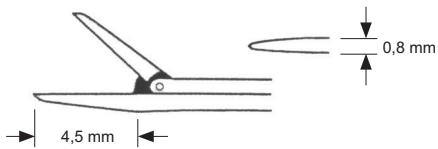
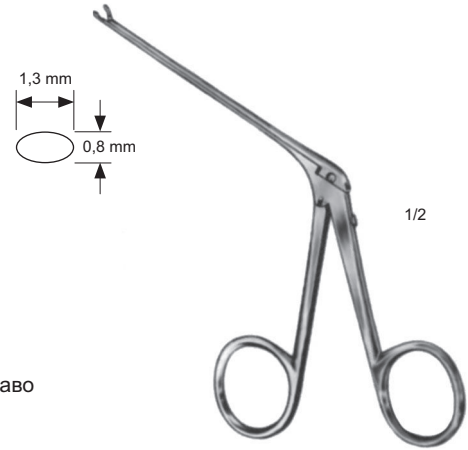

Mittelfein
L= 75 mm
80.0204

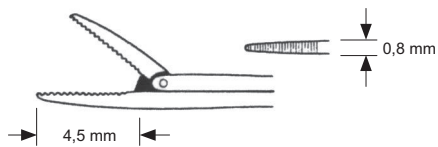

Mittelfein
L= 75 mm
80.0205

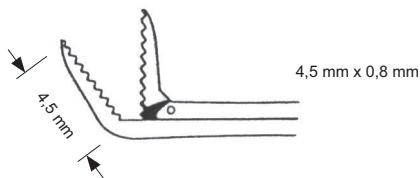

Mittelfein
L= 75 mm
80.0206

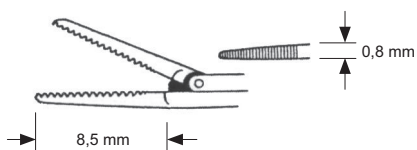

Bellucci
L= 80 mm
80.0207

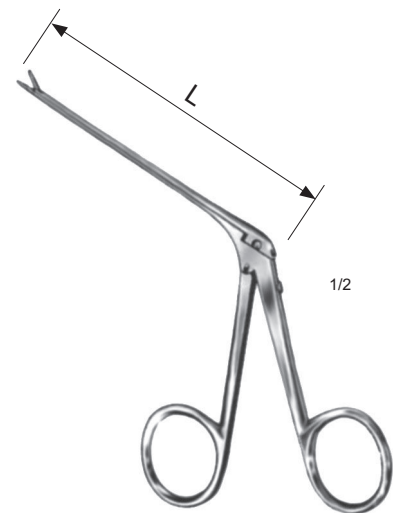

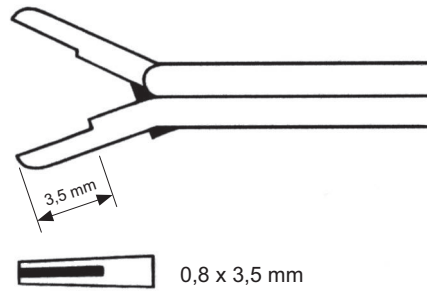

80.0208

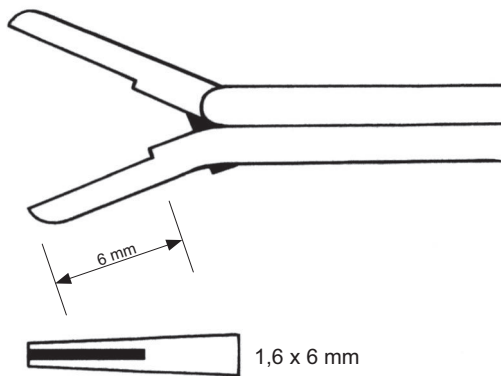

80.0209



Mc Gee

zakrzywiony w prawo • curved rightwards • изогнутый вправо



80.0210

zakrzywiony w lewo • curved leftwards • изогнутый влево



80.0211



Juers

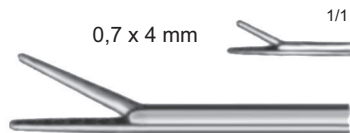

gładki, prosty
 smooth, straight
 гладкий, прямой **80.0212**

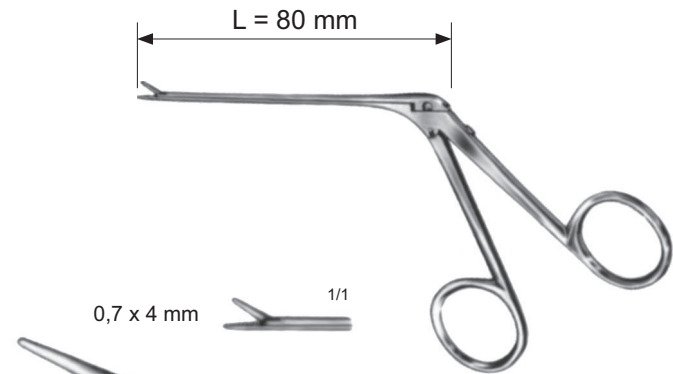

prosty
 straight
 прямой **80.0213**

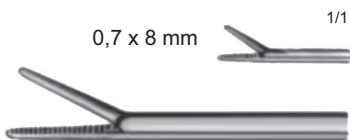

prosty
 straight
 прямой **80.0214**

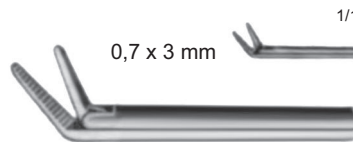

zagięty do góry
 curved upwards
 изогнутый вгору **80.0215**

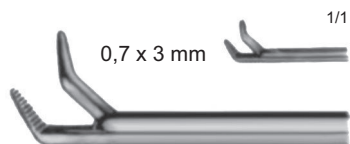

zagięty w prawo
 curved rightwards
 изогнутый вправо **80.0216**

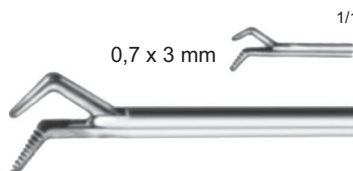

zagięty w lewo
 curved leftwards
 изогнутый влево **80.0217**

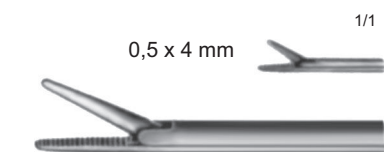

prosty
 straight
 прямой **80.0218**

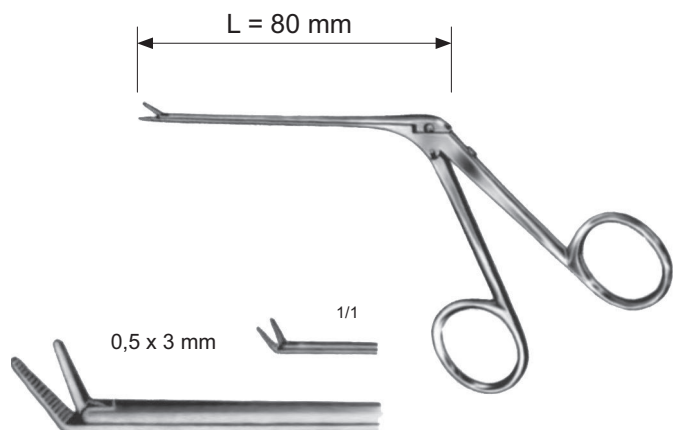

zagięty do góry
 curved upwards
 изогнутый вгору **80.0219**

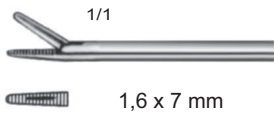

Hartmann
 L= 80 mm **80.0220**
 L= 140 mm **80.0221**
 L= 160 mm **80.0222**

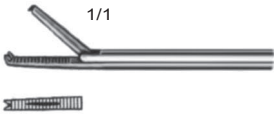

Hartmann
 L= 85 mm **80.0223**
 L= 140 mm **80.0224**

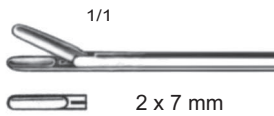

Hartmann
 L= 80 mm **80.0225**



Hartmann
 L= 85 mm **80.0226**

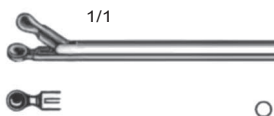

Hartmann
 L= 80 mm
 2,0 mm **80.0227**
 2,2 mm **80.0228**
 2,5 mm **80.0229**
 3,0 mm **80.0230**

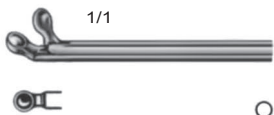

Hartmann
 L= 80 mm
 2,0 mm **80.0231**
 2,5 mm **80.0232**
 3,0 mm **80.0233**

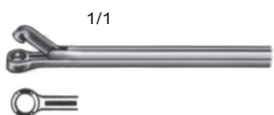

Hartmann-Hoffmann
 L= 85 mm **80.0234**

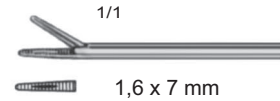
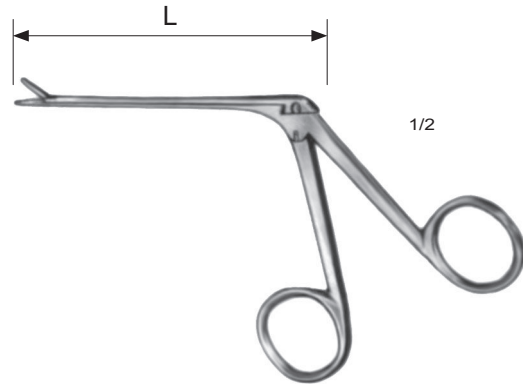

Hartmann-Wullstein
 L= 85 mm **80.0235**

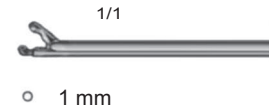

Hartmann-Wullstein
 L= 85 mm **80.0236**

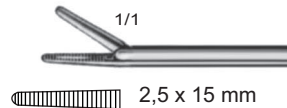

Hartmann-Noyes
 L= 90 mm **80.0237**

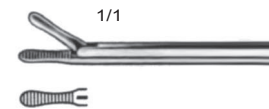

Duckbill
 L= 85 mm **80.0238**

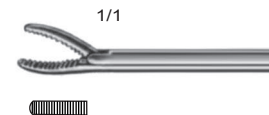



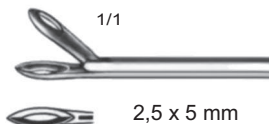

Weingärtner
 L= 85 mm **80.0239**

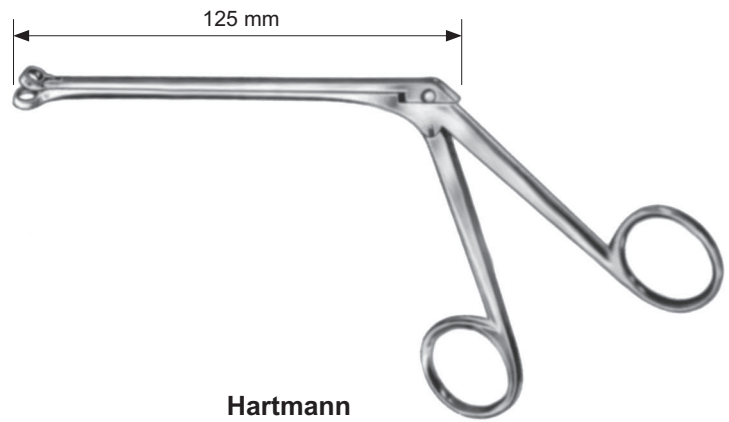



Strümpel
 L= 85 mm **80.0240**



-  5 mm **80.0241**
-  7 mm **80.0242**
-  9 mm **80.0243**
-  11 mm **80.0244**



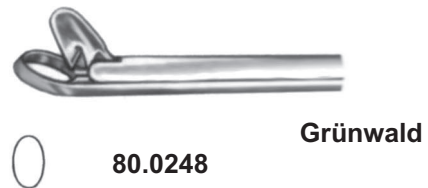

-  **80.0245**
-  **80.0246**
-  **80.0247**



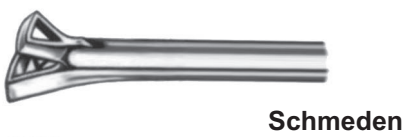



-  **80.0248**

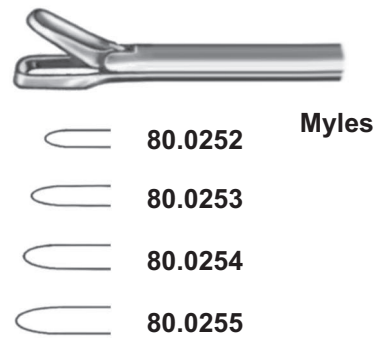



-  **80.0249**
-  **80.0250**
-  **80.0251**





-  **80.0252**
-  **80.0253**
-  **80.0254**
-  **80.0255**

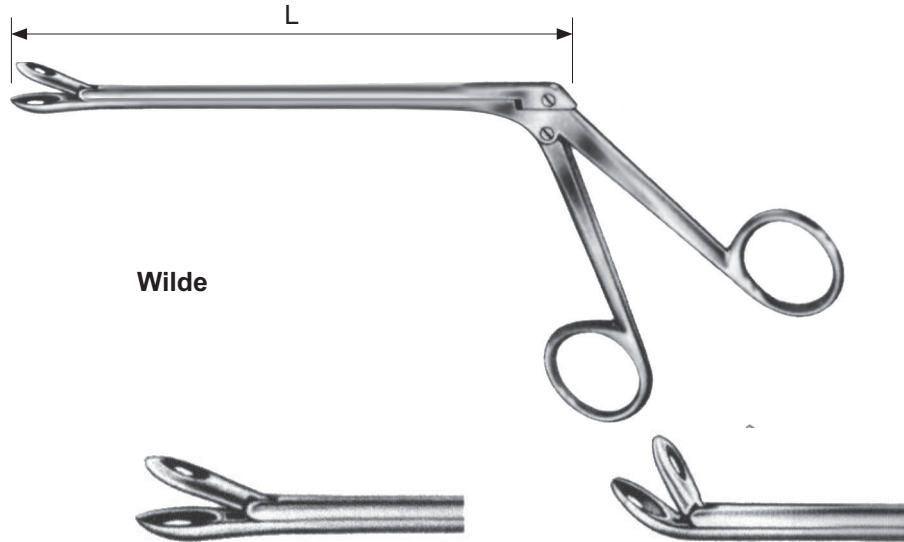

-  **80.0256**
-  **80.0257**



Wilde

		L = 130 mm	L = 170 mm	L = 130 mm	L = 170 mm
1/1		80.0258	80.0261	80.0264	80.0267
		80.0259	80.0262	80.0265	80.0268
		80.0260	80.0263	80.0266	80.0269



Watson-Williams

80.0270

L = 125 mm



Watson-Williams

80.0271

L = 125 mm

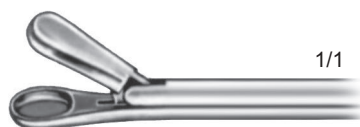

Watson-Williams

80.0272

L = 125 mm

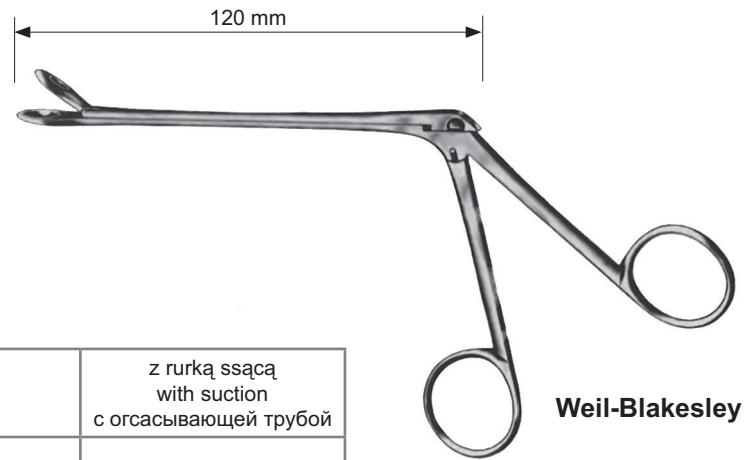

Prosty • Stright • Прямой

			standard	z rurką ssącą with suction с огсасывающей трубой
1/1		2,5 mm	80.0273	80.0288
		3,6 mm	80.0274	80.0289
		4,8 mm	80.0275	
		5,3 mm	80.0276	
		6,3 mm	80.0277	



Zakrzywiony 45° do góry • 45° curved upwards • Изогнутый 45° вверх

			standard	z rurką ssącą with suction с огсасывающей трубой
1/1		2,5 mm	80.0278	80.0293
		3,6 mm	80.0279	80.0294
		4,8 mm	80.0280	
		5,3 mm	80.0281	
		6,3 mm	80.0282	



Zakrzywiony 90° do góry • 90° curved upwards • Изогнутый 90° вверх

			standard
1/1		2,5 mm	80.0283
		3,6 mm	80.0284
		4,8 mm	80.0285
		5,3 mm	80.0286
		6,3 mm	80.0287

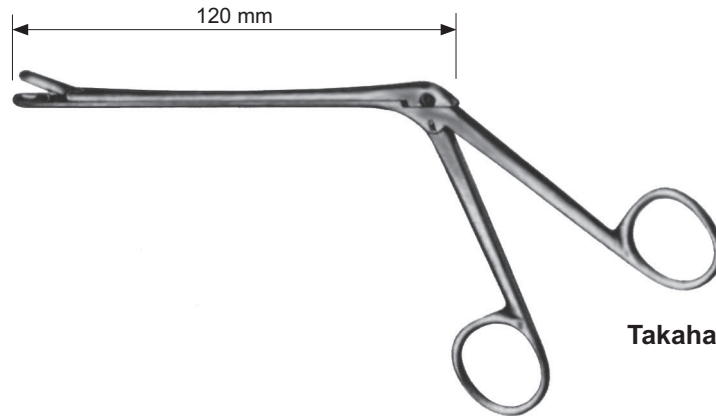

Takahashi

Prosty • Stright • Прямой



		standard	z rurką ssącą with suction с огсасывающей трубой
Fig. 1	2,5 mm	80.0303	80.0307
Fig.2	4.0 mm	80.0304	80.0308



Zakrzywiony 45° do góry • 45° curved upwards • Изогнутый 45° вверх



		standard	z rurką ssącą with suction с огсасывающей трубой
Fig. 1	2,5 mm	80.0305	80.0309
Fig.2	4.0 mm	80.0306	80.0310

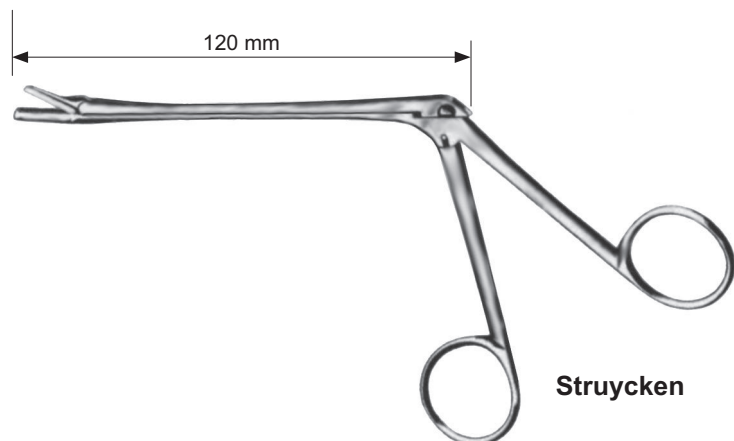
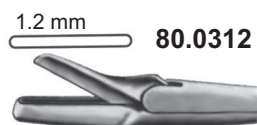
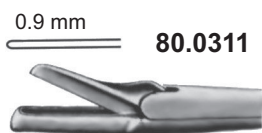

Struycken

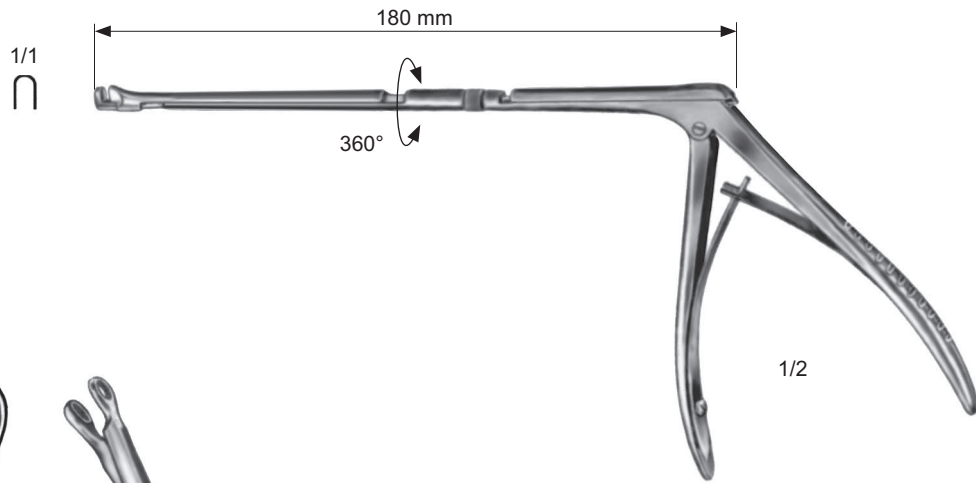

1/2

Hajek-Koffler
80.0313



1/1

Fig. 1 **80.0314**

Fig. 2 **80.0315**

Fig. 3 **80.0316**

Fig. 4 **80.0317**

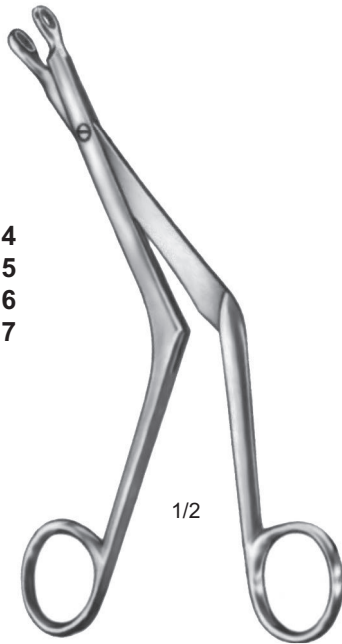

1/2

Bruning

1/1

1 mm **80.0318**

2 mm **80.0319**

3 mm **80.0320**

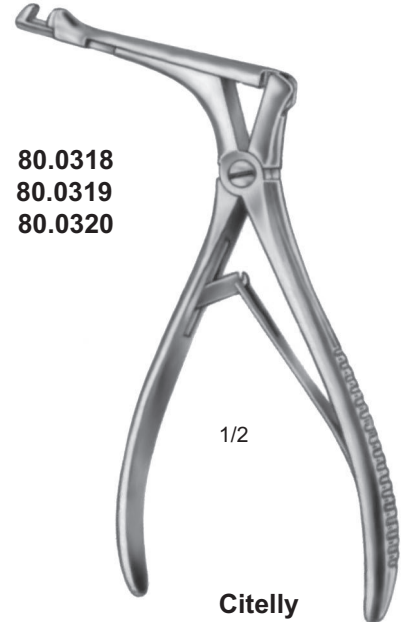

1/2

Citelly



tnący górą
cutting with the top part
режет верхом

1/1

80.0321



tnący dołem
cutting with the bottom part
режет низом

1/1





80.0322

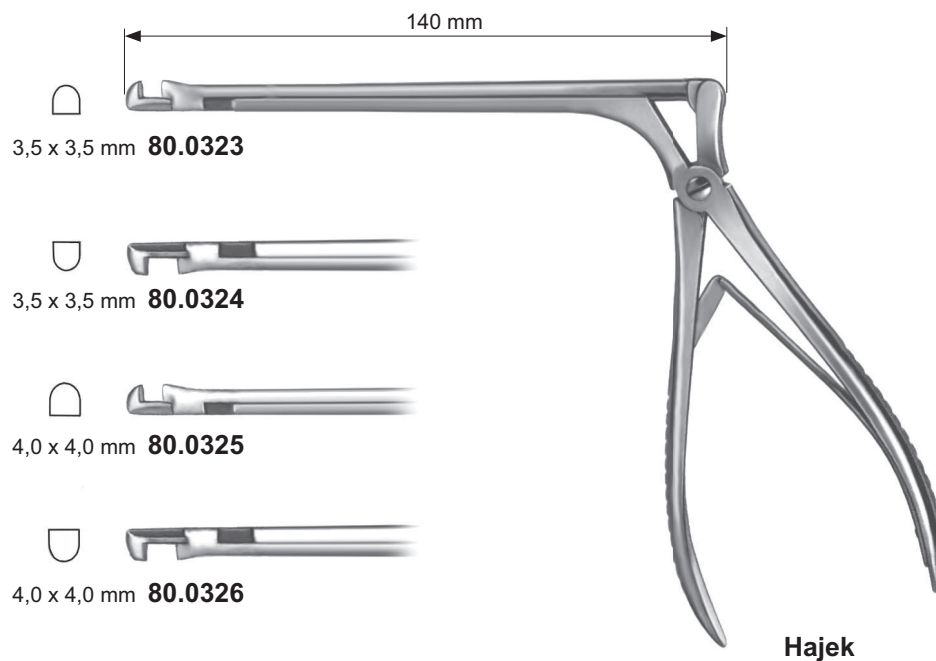

1/2

Ferris-Smith



-  3 x 3 mm **80.0329**
-  4 x 4 mm **80.0330**
-  5 x 5 mm **80.0331**
-  6 x 6 mm **80.0332**

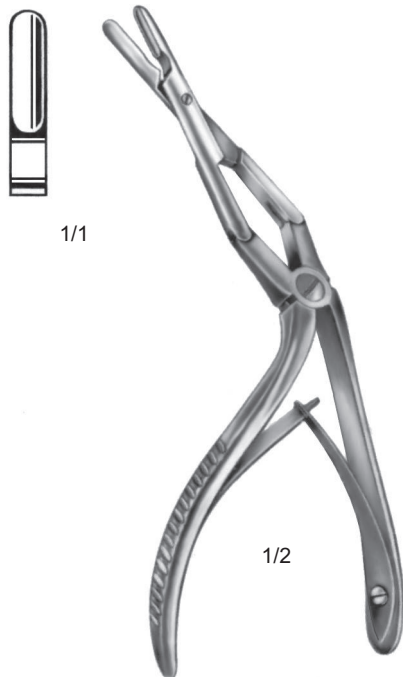

Middleton-Jansen
80.0333
 190 mm

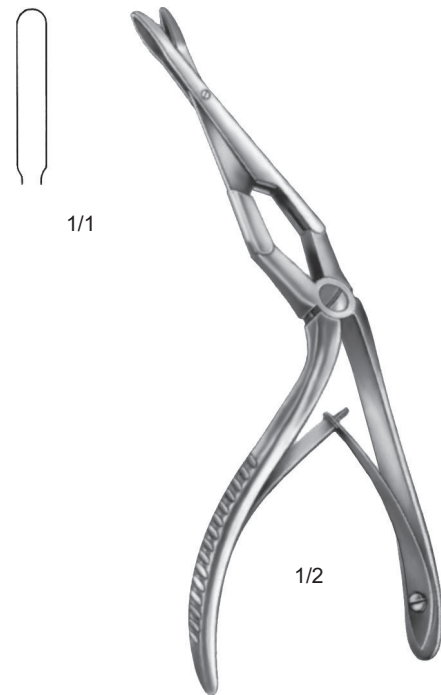

Middleton-Jansen
80.0334
 190 mm

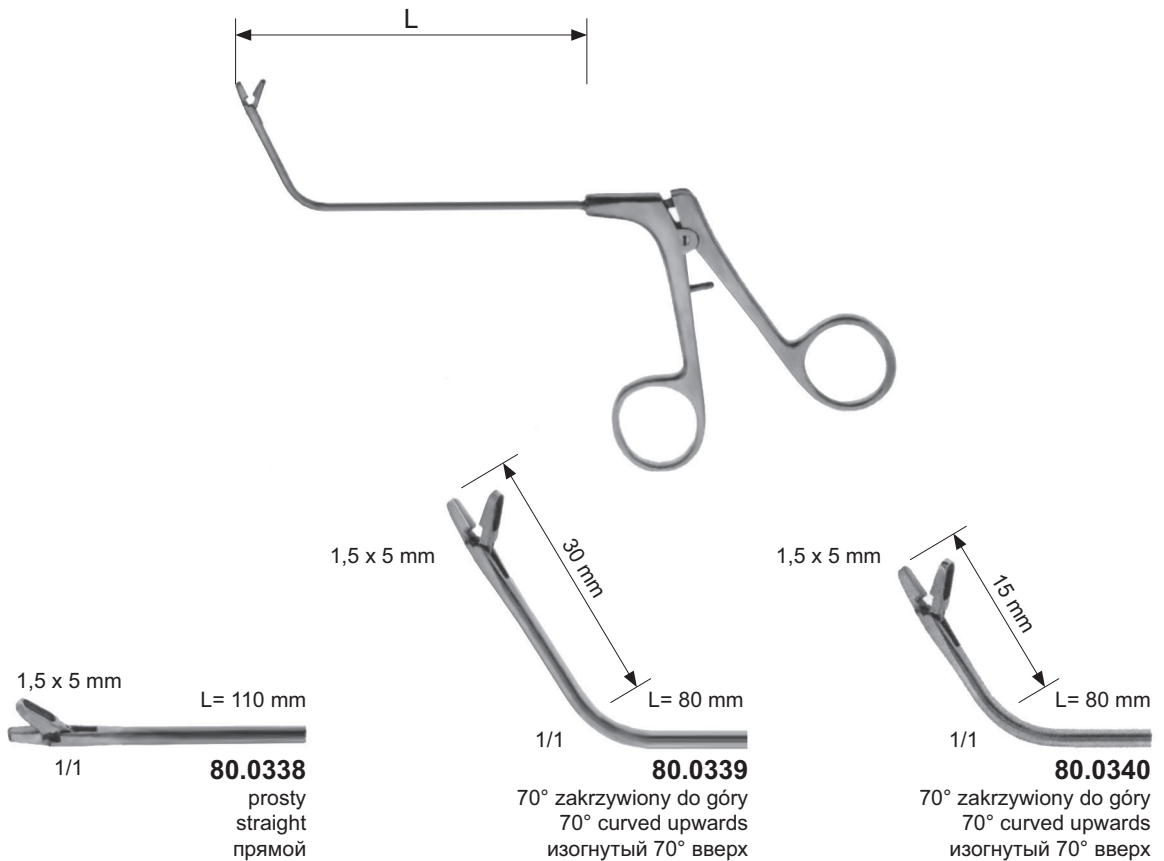
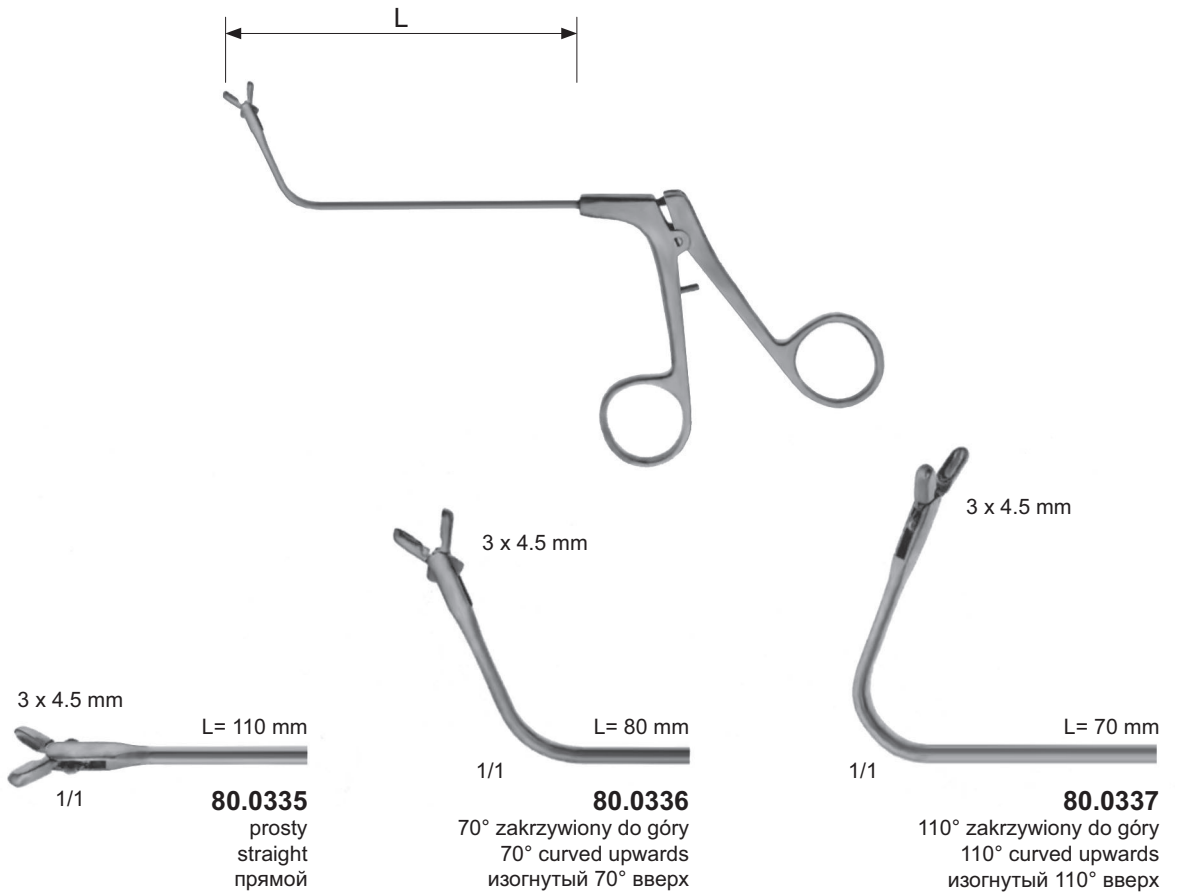



Kevorkian 80.0342



Tischler 80.0343



80.0344



80.0345



Ø4 mm 80.0346



1/2

**Huber
80.0341**



Bruenings

prosty
straight
прямой

L (mm)	prosty straight прямой
200	80.0350
300	80.0351
400	80.0352

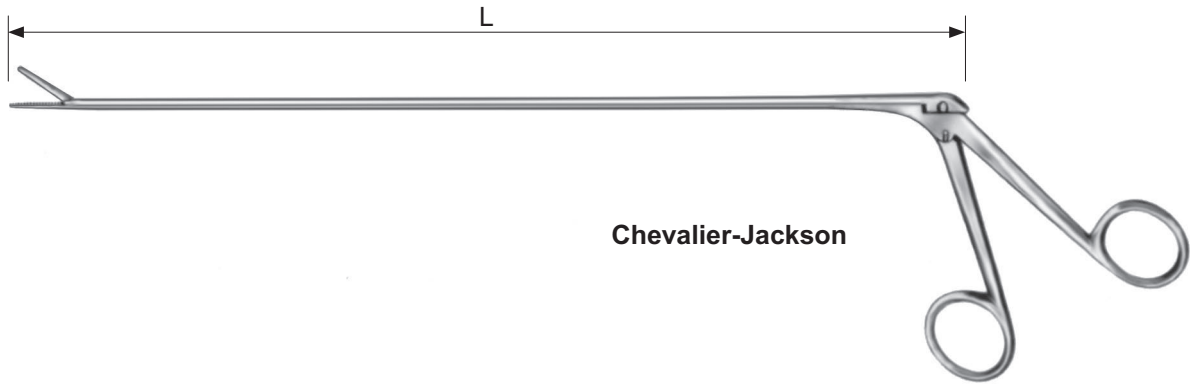

Chevalier-Jackson



L (mm)	
300	80.0362
400	80.0363
500	80.0364
600	80.0365



L (mm)	
300	80.0374
400	80.0375
500	80.0376
600	80.0377



L (mm)	
300	80.0366
400	80.0367
500	80.0368
600	80.0369

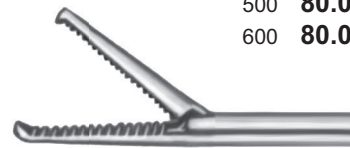

L (mm)	
300	80.0378
400	80.0379
500	80.0380
600	80.0381



L (mm)	
300	80.0370
400	80.0371
500	80.0372
600	80.0373



L (mm)	
300	80.0382
400	80.0383
500	80.0384
600	80.0385



L (mm)	Ø 2 mm	Ø 4 mm	Ø 6 mm
300	80.0386	80.0390	80.0394
400	80.0387	80.0391	80.0395
500	80.0388	80.0392	80.0396
600	80.0389	80.0393	80.0397



L (mm)	Ø 2 mm	Ø 4 mm	Ø 6 mm
300	80.0398	80.0402	80.0406
400	80.0399	80.0403	80.0407
500	80.0400	80.0404	80.0408
600	80.0401	80.0405	80.0409

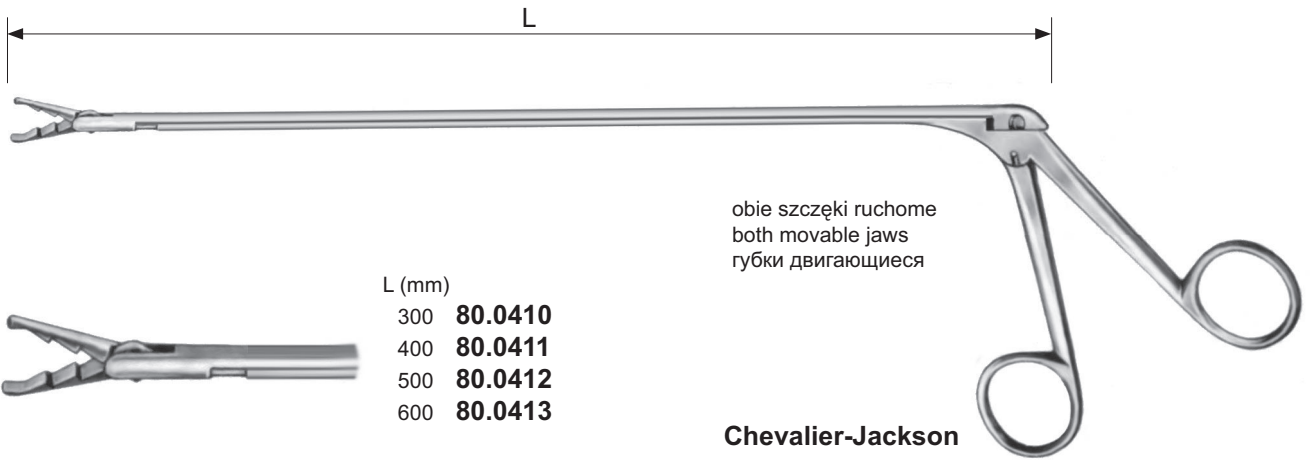

L (mm)
300 **80.0410**
400 **80.0411**
500 **80.0412**
600 **80.0413**



L (mm)
300 **80.0414**
400 **80.0415**
500 **80.0416**
600 **80.0417**





L (mm)
300 **80.0418**
400 **80.0419**
500 **80.0420**
600 **80.0421**



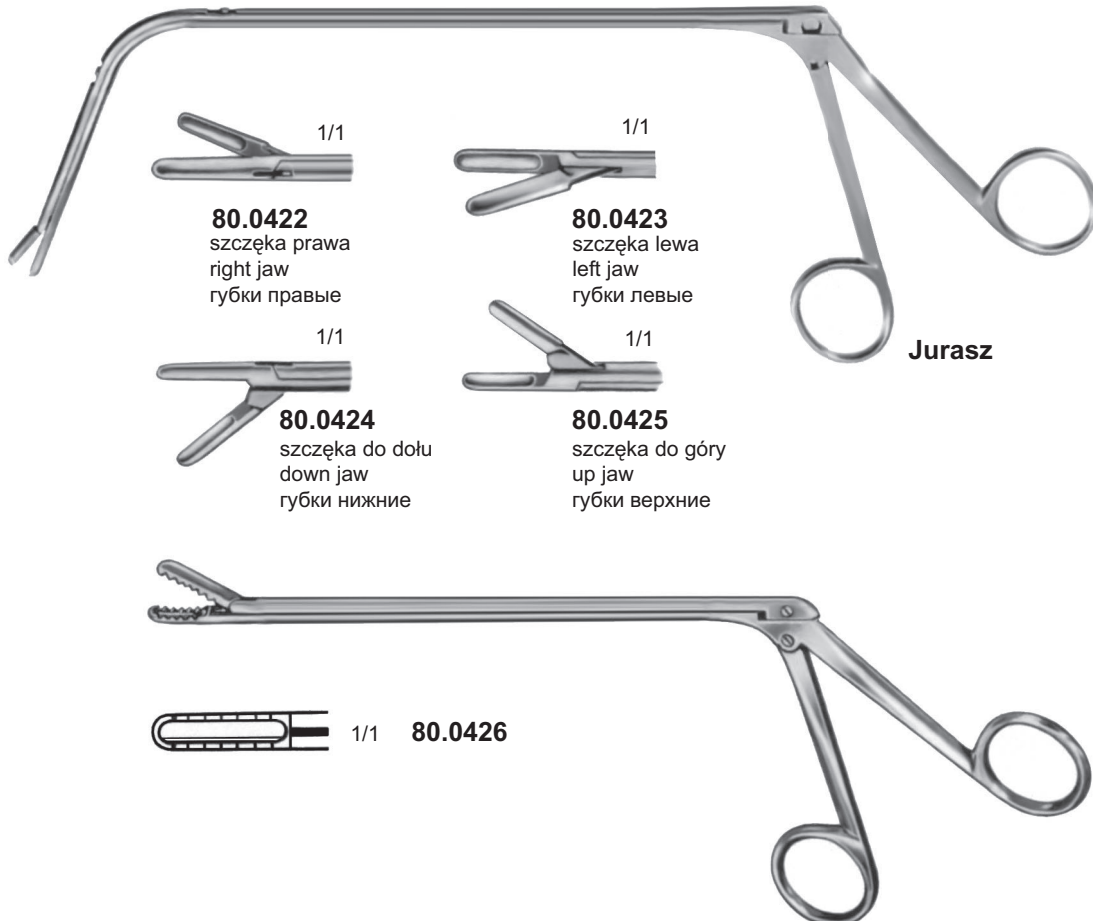

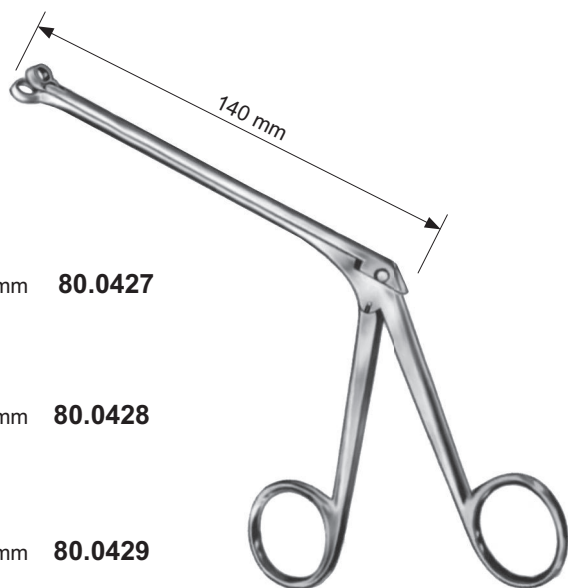
Kleszczyki krtniowe do polipów • Laryngeal - Polypus forceps • Зажимы полипные для ларингологии





 1/1 Ø 5 mm **80.0427**

 1/1 Ø 7 mm **80.0428**

 1/1 Ø 9 mm **80.0429**

 1/1 Ø 11 mm **80.0430**

Hartmann





Schmeden

 1/1 **80.0431**

 1/1 **80.0432**

 1/1 **80.0433**

 1/1 Ø 11 mm **80.0434**

 1/1 Ø 15 mm **80.0435**

 1/1 Ø 17 mm **80.0436**

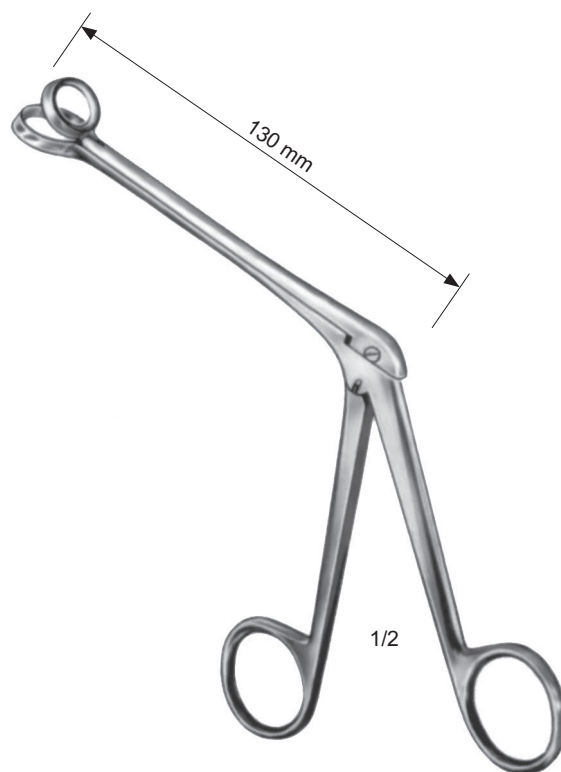

Hartmann